

CR0603 / CR0805 / CR1206

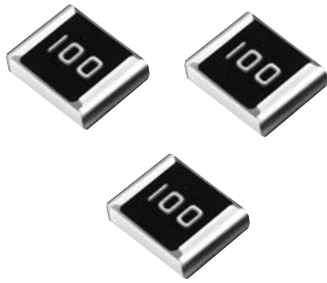

特征

- 符合RoHS *
- 在70 额定功率：cr0603-0.10w , cr0805-0.125W , 0.25Wcr1206
- 底电极宽度公差
- 适用于所有类型的焊接工艺
- 三层的接触过程中镍屏障阻止浸出和提供优良的可焊性
- 纸带上自动安装的卷

电气特性

Characteristic	Model CR0603	Model CR0805	Model CR1206
Power Rating @ 70 °C	1/10 W	1/8 W	1/4 W
Operating Temperature Range	-55 °C to +155 °C		
Derated to 0 Load at	+155 °C		
Maximum Working Voltage	50 V	150 V	200 V
Maximum Overload Voltage	100 V	300 V	400 V
Resistance Range: 1 %, E-96 + E-24	10 ohms - 1 megohm		
Resistance Range: 5 %, E-24 Zero Ohm Jumper <0.01 ohms	1 ohms - 10 megohms		
Temperature Coefficient	Special value on request 1 %: ±100 ppm/°C 5 %: ±200 ppm/°C 1 ohm - 10 ohms: -200 ppm/°C to +500 ppm/°C		

特征数据

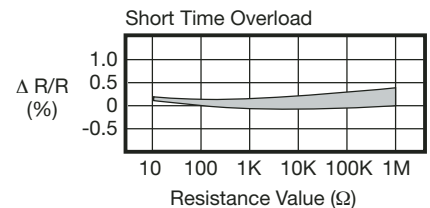
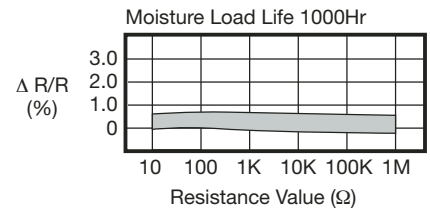
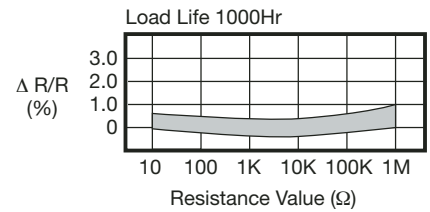

For Standard Values Used in Capacitors, Inductors, and Resistors, [click here](#).

贴片尺寸规格

Dimension	Model CR0603	Model CR0805	Model CR1206
L	$\frac{1.60 \pm 0.10}{(0.063 \pm 0.004)}$	$\frac{2.00 \pm 0.15}{(0.079 \pm 0.006)}$	$\frac{3.20 \pm 0.25}{(0.126 \pm 0.010)}$
W	$\frac{0.80 \pm 0.10}{(0.031 \pm 0.004)}$	$\frac{1.25 \pm 0.15}{(0.049 \pm 0.006)}$	$\frac{1.60 \pm 0.15}{(0.063 \pm 0.006)}$
H	$\frac{0.45 \pm 0.10}{(0.018 \pm 0.004)}$	$\frac{0.50 \pm 0.10}{(0.020 \pm 0.004)}$	$\frac{0.60 \pm 0.15}{(0.024 \pm 0.006)}$
l ₁	$\frac{0.30 \pm 0.20}{(0.012 \pm 0.008)}$	$\frac{0.40 \pm 0.20}{(0.016 \pm 0.008)}$	$\frac{0.50 \pm 0.25}{(0.020 \pm 0.010)}$
l ₂	$\frac{0.30 \pm 0.20}{(0.012 \pm 0.008)}$	$\frac{0.40 \pm 0.20}{(0.016 \pm 0.008)}$	$\frac{0.50 \pm 0.20}{(0.020 \pm 0.010)}$

尺寸图

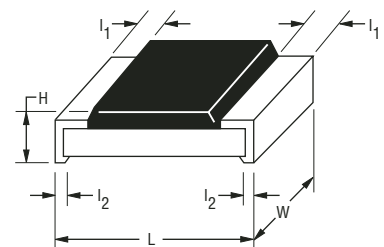

降额曲线

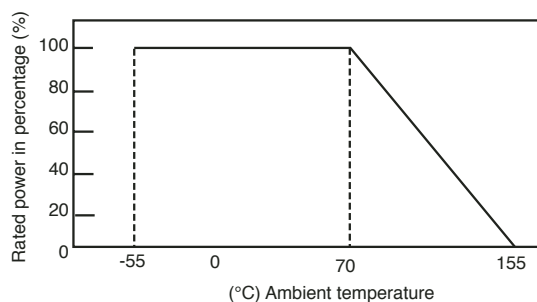

DIMENSIONS ARE: $\frac{\text{MM}}{\text{(INCHES)}}$

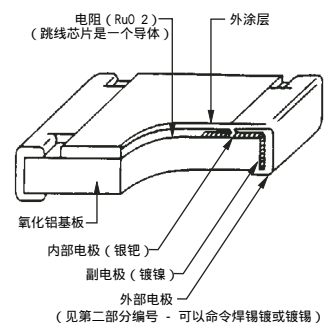

CR0603 / CR0805 / CR1206
Performance Characteristics (Tests According to MIL-STD-202, MIL-R-55342B, EIA RS-396)

Test	Procedure	Method	Specification	Deviation from Nominal	
				1 %	5 %
DC Resistance	—	MIL-STD-202 303 EIA RS-396 4.4	MIL-R-55342D 4.7.2	F: $\leq \pm 1 \%$	$\leq \pm 5.0 \%$
Thermal Shock	-40 °C, 60 minutes; +125 °C, 60 minutes	MIL-STD-202 107 EIA RS-396 4.5	MIL-R-55342D 4.7.3	$\leq \pm 0.5 \%$ +0.05 Ω	$\leq \pm 1 \%$ +0.05 Ω
Low Temperature Operation	-55 °C, 1 hour off; 45 minutes on	MIL-R-55342D 4.7.4 EIA RS-396 4.6	MIL-R-55342D 4.7.4	$\leq \pm 0.5 \%$ 0.05 Ω	$\leq \pm 1.0 \%$ +0.05 Ω
Short Time Overload	Rated Voltage x 2.5; 5 seconds CR0603: 100 V max. CR0805: 300 V max. CR1206: 400 V max.	MIL-R-55342D 4.7.5 EIA RS-396 4.7	MIL-R-55342D 4.7.5	$\leq \pm 1 \%$ +0.05 Ω	$\leq \pm 2.0 \%$ +0.05 Ω
High Temperature Exposure	+125 °C; 1000 hours	MIL-R-55342D 4.7.6 EIA RS-396 4.8	MIL-R-55342D 4.7.6	$\leq \pm 1.0 \%$ +0.05 Ω	$\leq \pm 2.0 \%$ +0.1 Ω
Resistance to Soldering Heat	260 °C, 10 seconds	MIL-R-55342D 4.7.7	MIL-R-55342D 4.7.7	$\leq \pm 0.5 \%$ +0.05 Ω	$\leq \pm 1.0 \%$ +0.05 Ω
Moisture Resistance	90-98 %RH; 10 cycles	MIL-STD-202 106D EIA RS-396 4.9	MIL-R-55342D 4.7.8	$\leq \pm 0.5 \%$ +0.05 Ω	$\leq \pm 2.0 \%$ +0.05 Ω
Load Life 1000 Hours	+70 °C; 1.5 hours on, 0.5 hours off; 1000 hours	MIL-STD-202 108 Condition D EIA RS-396 4.12	MIL-R-55342D 4.7.10	$\leq \pm 1.0 \%$ +0.05 Ω	$\leq \pm 3.0 \%$ +0.1 Ω
Solderability	+235 °C; 3 seconds	MIL-STD-202 208 EIA RS-396 4.11	MIL-R-55342D 4.7.11	$\geq 95 \%$ of area covered	$\geq 95 \%$ of area covered
Terminal Strength	Pull Test	MIL-R-55342D 4.7.12	MIL-R-55342D 4.7.12	≥ 500 g	≥ 500 g
Current Noise	Quan-Tech Model 315B	MIL-STD-202 308	MIL-R-55342D 6.6	$R \leq 1k \Omega$; max. 1 $\mu V/V$ $R \leq 10k \Omega$; max. 3 $\mu V/V$ $R \leq 100k \Omega$; max. 6 $\mu V/V$ $R \leq 1M \Omega$; max. 10 $\mu V/V$	$R \leq 1k \Omega$; max. 1 $\mu V/V$ $R \leq 10k \Omega$; max. 3 $\mu V/V$ $R \leq 100k \Omega$; max. 6 $\mu V/V$ $R \leq 2M \Omega$; max. 10 $\mu V/V$
Humidity, Steady State	+40 °C; 90-95 % RH, 1344 Hours	MIL-STD-202 103B Condition D	—	$\leq \pm 2.5 \%$ +0.05 Ω	$\leq \pm 2.5 \%$ +0.05 Ω
Salt Spray	96 hours	MIL-STD-202 101D Condition A	—	$\leq \pm 1.0 \%$ +0.2 Ω	$\leq \pm 1.0 \%$ +0.1 Ω
Vibration	10-2000 Hz, 6 hours	MIL-STD-202 201A	—	$\leq \pm 0.5 \%$ +0.1 Ω	$\leq \pm 1.0 \%$ +0.1 Ω
Voltage Coefficient	—	MIL-STD-202 309	—	≤ 100 ppm/V	≤ 100 ppm/V
Insulation Resistance	Test Potential 500V CR0603: 100V	MIL-STD-202 302 Condition B	—	$\geq 10^9 M \Omega$	$\geq 10^9 M \Omega$
Dielectric Withstanding Voltage	—	MIL-STD-202 301	—	≥ 500 V (CR1206, CR0805) ≥ 300 V (CR0603)	
Drop Test	1 m	MIL-STD-202 203B	—	$\leq \pm 0.5 \%$ +0.1 Ω	$\leq \pm 1.0 \%$ +0.1 Ω
Bending Test	5 mm/90 mm; 10 sec.	—	—	$\leq \pm 1 \%$ +0.05 Ω	$\leq \pm 1.0 \%$ +0.05 Ω

CR0603 / CR0805 / CR1206

Soldering Profile for RoHS Compliant Chip Resistors and Arrays

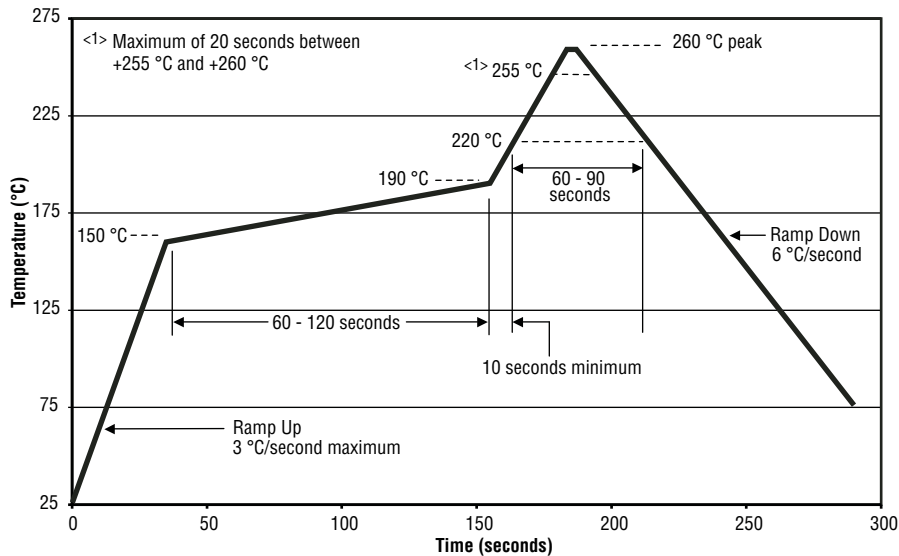

Packaging Dimensions (Conforms to EIA RS-481A)

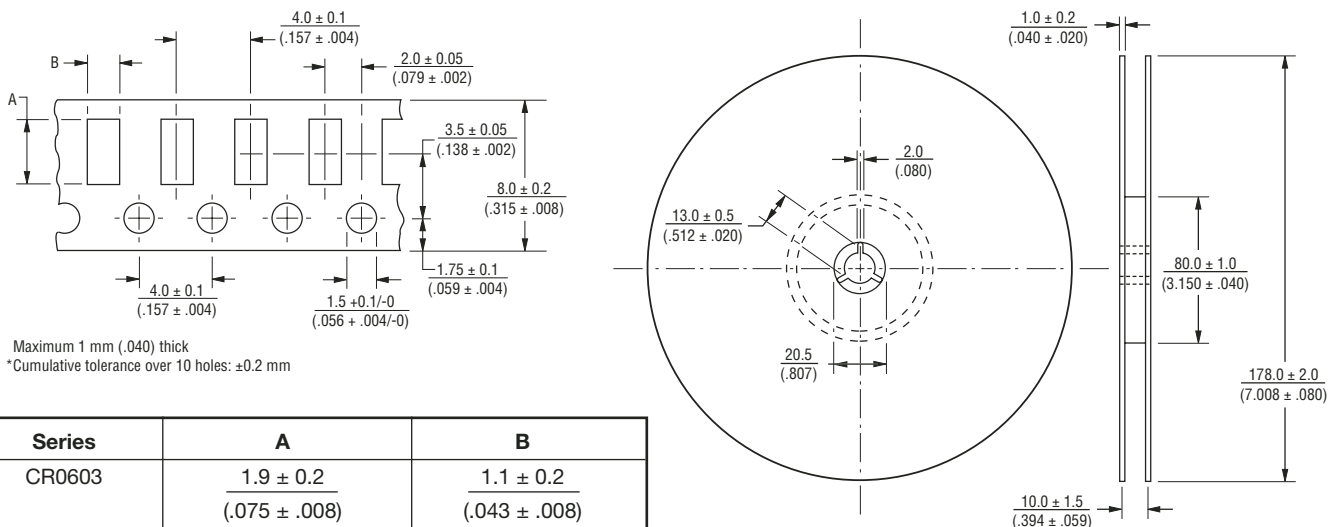

Marking on reel: Part number, quantity, resistance value and tolerance, date code.

CR0603 / CR0805 / CR1206

Resistor Markings

CR0603
CR0805
CR1206



E-24 marking
Value = 10K ohms

CR0805
CR1206



E-96 marking
Value = 44.2K ohms

CR0603
EIA-96 Marking



1 % marking
Value = 12.4K ohms

Marking Explanation

- E-24: 3 digits, first two digits are significant, third digit is number of zeros.
Letter R is decimal point.
 - E-96: 4 digits, first three digits are significant, fourth digit is number of zeros.
Letter R is decimal point.
- 0603 E-96: EIA-96 marking (see table below).

EIA-96 Marking for CR0603, 1 %

Code	R Value	Code	R Value	Code	R Value	Code	R Value	Code	R Value	Code	R Value	Code	R Value	Code	R Value
01	100	13	133	25	178	37	237	49	316	61	422	73	562	85	750
02	102	14	137	26	182	38	243	50	324	62	432	74	576	86	768
03	105	15	140	27	187	39	249	51	332	63	442	75	590	87	787
04	107	16	143	28	191	40	255	52	340	64	453	76	604	88	806
05	110	17	147	29	196	41	261	53	348	65	464	77	619	89	825
06	113	18	150	30	200	42	267	54	357	66	475	78	634	90	845
07	115	19	154	31	205	43	274	55	365	67	487	79	649	91	866
08	118	20	158	32	210	44	280	56	374	68	499	80	665	92	887
09	121	21	162	33	215	45	287	57	383	69	511	81	681	93	909
10	124	22	165	34	221	46	294	58	392	70	523	82	698	94	931
11	127	23	169	35	226	47	301	59	402	71	536	83	715	95	953
12	130	24	174	36	232	48	309	60	412	72	549	84	732	96	976

This table shows the first two digits for the three-digit EIA-96 part marking scheme. The third character is a letter multiplier:
 $Y=10^{-2}$ $X=10^{-1}$ $A=10^0$ $B=10^1$ $C=10^2$ $D=10^3$ $E=10^4$ $F=10^5$



CR0603 / CR0805 / CR1206

How To Order

CR 1206 - F X - 8252 E LF

Model _____
(CR = Chip Resistor)

Size _____

- 0603
- 0805
- 1206

Resistance Tolerance _____
 F = ±1 %Used with "X" TCR code only for values from 10 ohms through 1 megohm.
 J = ±5 %Used with "W" TCR code for values from 10 ohms through 10 megohms. Used with "/" TCR code for zero ohm (jumper) and for values from 1 ohm through 9.1 ohms.

TCR (ppm/°C) _____
 X = ±100Used with "F" Resistance Tolerance code only for values from 10 ohms through 1 megohm.
 W = ±200Used with "J" Resistance Tolerance code for values from 10 ohms through 10 megohms.
 / = -250 to +500 ..Used with "J" Resistance Tolerance code only for zero ohm (jumper), and for values from 1 ohm through 9.1 ohms.

Resistance Value _____
 For 1 % Tolerance:
 <100 ohms "R" represents decimal point (example: 24R3 = 24.3 ohms)
 ≥100 ohmsFirst three digits are significant, fourth digit represents number of zeros to follow (example: 8252 = 82.5k ohms).
 For 5 % Tolerance:
 <10 ohms "R" represents decimal point (example: 4R7 = 4.7 ohms)
 ≥10 ohmsFirst two digits are significant, third digit represents number of zeros to follow (example: 474 = 470k ohms; 000 = Jumper).

Packaging _____
 E = Paper Tape (5,000 pcs.) on 7 " Plastic Reel

Termination _____
 LF = Tin-plated (RoHS compliant)